

Cord Operated Drapery Track Systems

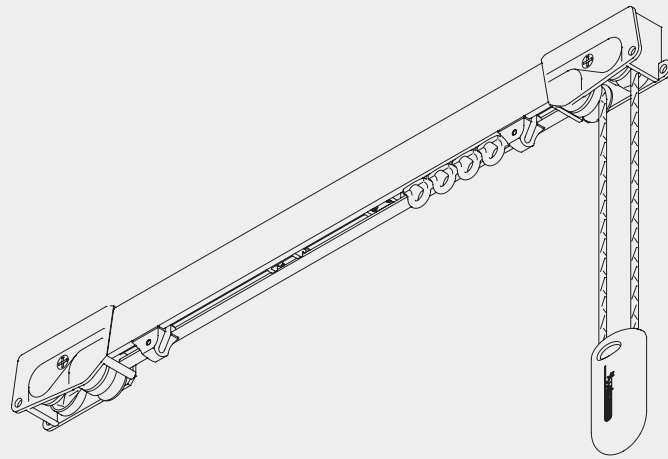

Cord Operated Drapery Track System

Silent Gliss® 6350



Product Information

- Cord operated drapery track system for commercial as well as residential use.
- For medium weight applications (max. 84 lbs); see weight chart.
- The maximum length of the system is 39'. It depends on fabric weight, application and use of glider or rollers.
- Strong profile with concealed channel.
- Bendable up to a minimum radius of 12".
- Easy wall or ceiling mounting possibilities.
- Standard colors: anodized aluminium or white powder coat.
- Standard length of the profiles are 20'.



6350

Profile and Bending Information

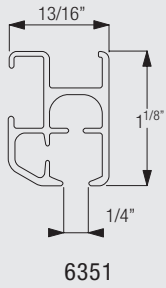

How to measure

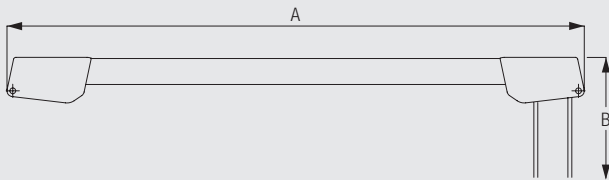

A: system width
B: cord height

System Dimensions



39 ft



84 lbs

Max. Curtain Weight Chart (with glider)







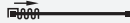

6350

	7 ft	13 ft	20 ft	27 ft	33 ft	39 ft
	53	49	44	42	38	33
	62	57	55	51	49	44
	49	42	35	29	22	-
	55	49	42	35	29	-
	38	33	29	22	18	-
	49	42	35	29	22	-

(lbs max)

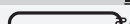
Max. Curtain Weight Chart (with roller 6098)

	10 ft	13 ft	20 ft	27 ft	33 ft	39 ft
	75	73	68	64	60	55
	86	82	77	73	71	66
	60	53	46	40	33	-
	71	64	57	51	44	-
	49	44	40	33	29	-
	60	53	46	40	33	-

(lbs max.)

System Options

S-Fold / Z-Fold Application



- 6331 Snap Glider
- 6339 Base
- 5202 Roller
- 6338 Butt Master Center Draw
- 6342 Overlap Master
- 6347 Butt Master One Way Draw
- 6333 100% Spacer Cord
- 6334 120% Spacer Cord
- 6325/6324 Shoe

Fitting Information

Bracket Positioning

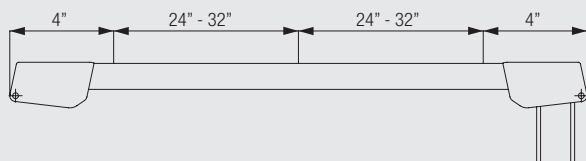

Fixation with universal click-in bracket

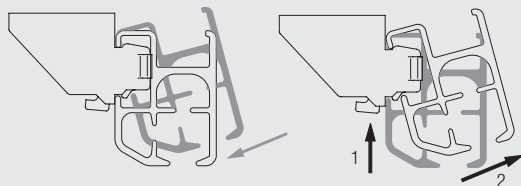

Applicable with 3603/3630/3655/3660

Installation: Roll track onto bracket in direction indicated
Removal: 1. Press to release 2. Rotate forward for removal



6350

Mounting Options

Ceiling mounting with bracket 3603

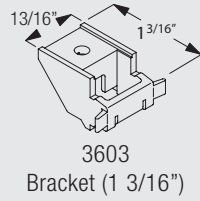
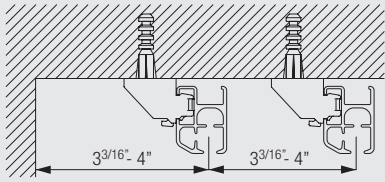

Wall mounting with brackets 3630, 3655 and 3660

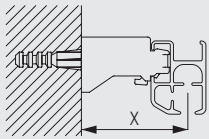

	X (in)
3630	1 15/16
3655	2 1/2
3660	3 1/16

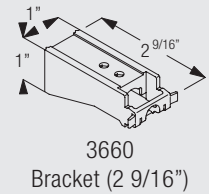
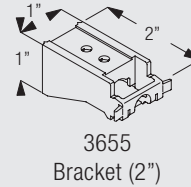
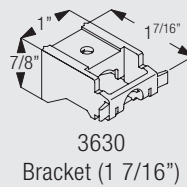

Wall mounting with adjustable brackets 0829, 0831 with slider 0828 and clamp 3603

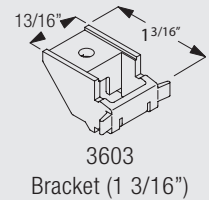
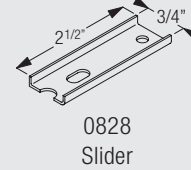
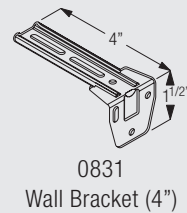
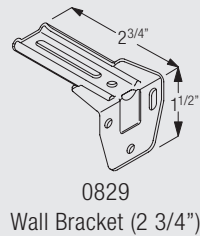
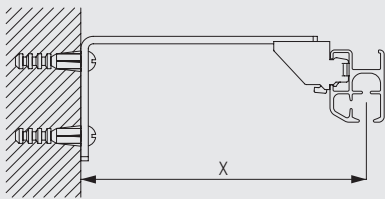

Standard Accessories

6350

3093 Cord (ø 3/16")



3340 Cord/Chain weight



3603 Bracket (1 3/16")



6053 Spring stop



6063 Overlap arm



6086 End stop (removable)



6098 Roller



6351 Profile



Sets

6358 Guide return set for straight and bend applications, containing

6354 Pilot runner

2



6355 Guide left

1

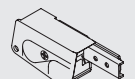

6356 Guide right

1

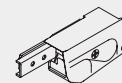

Optional Accessories

0829 Wall Bracket (2 3/4")



0831 Wall Bracket (4")



3630 Bracket (1.4")

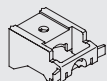

3655 Bracket (2")

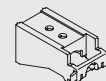

3660 Bracket (2.4")

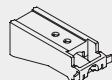

3735 Cord tensioner with spring



6013 Endstop



6064 Screw twist endstop



6065 Eye endstop



6094 Roller w/ hook



Sewing Accessories

3571 Hook



3582 Hook



3599 Hook



6146 Hook



Useful Measures

3620 Connecting bridge

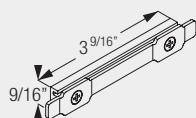

6063 Overlap arm

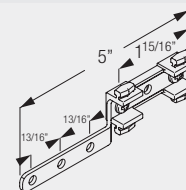

6350



6350

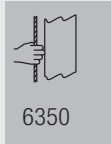

www.silentgliss-usa.com

Silent Gliss USA Inc.
1850 Beaver Ridge Circle, Suite A
Norcross GA 30071

Phone: 770-466-4811
Toll Free: 1-800-938-7225
Fax: 770-466-4814
info@silentgliss-usa.com

www.brading.com

Brading Specialty Shades
3204 Yonge Street
Toronto, ON M4N 2L2

Phone: 416-488-6600
Toll Free: 1-866-BRADING
Fax: 416-488-9821
info@brading.com