

# Room Divider/Cubicle/ Shower Rail Systems

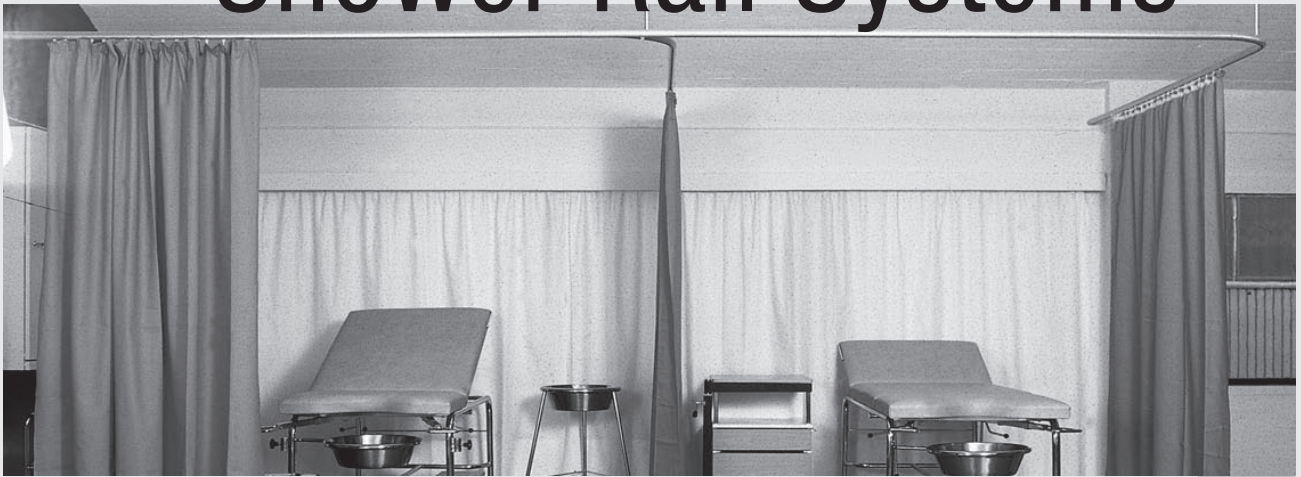

## Room Divider/Cubicle/Shower Rail System

# Silent Gliss® 6650 Safety Device

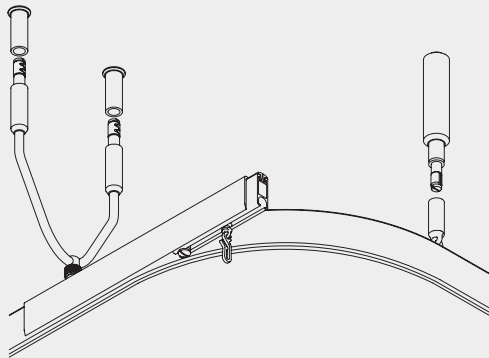

### Product Information

- The 6650 Safety Device System has been designed for specific use in high risk areas to reduce the opportunity for self-harm. The precision-engineered pull-out ensures that the device will remain in place during normal everyday use. The 6650 has been developed to work exclusively with Silent Gliss 6101 Cubicle Track and is complete with single hangers, V-hanger for lateral stability, wall supports and wall bracket systems (patent pending), thereby covering the vast majority of layouts as well as for fast and simple retrofitting of existing layouts.
- Neat, strong system designed around the proven existing 6101 track.
- Single hanger incorporates a friction-based joint (patent pending) which will progressively separate within a stated maximum load.
- Designed with maximum protection from wear and tear to minimise inspection and future replacement.
- Separation of single hanger is at track level for easy replacement.
- Progressive separation of the 6651 acts as a warning and reduces incidences of separation through over heavy handling of curtains, etc.
- The inclusion of the friction-based joint also in the V-hanger for lateral stability means that a safe environment is achievable without compromising layout design. The V-hanger has been specifically designed to separate under the same maximum load as the single hanger 6651.
- The unique wall support (patent pending) is designed to take lateral and vertical downward pressure without causing damage to the support.
- The wall brackets allow bed returns, etc., to be included in the design to meet layout specifications.
- A detachable connecting bridge reduces the risk of the domino effect where one collapsing cubicle brings down attached systems.



6650

## Profile and Bending Information

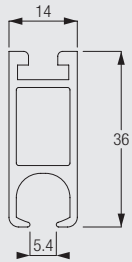

6101



Standard radius 200mm.

The standard radius is recommended for optimal operation. The minimum possible radius is 150mm.

The 6650 safety device system is designed for specific use with the 6100 cubicle system with the 6101 profile option only, it is **not** for use with the 6109 profile option.

## Safety Key Components

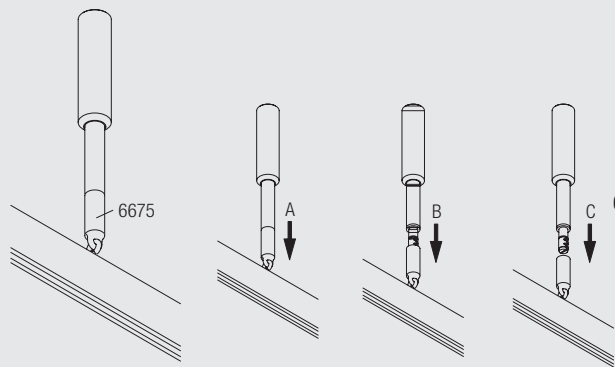

6675 safety device for single hanger  
Pictured here in the process of separating (a,b) and separated (c).



6650

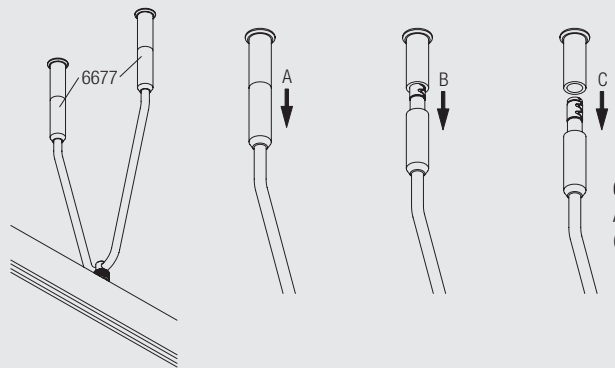

6677 safety device for V-hanger  
Assembly pictured here in the process of separating (a, b) and separated (c)

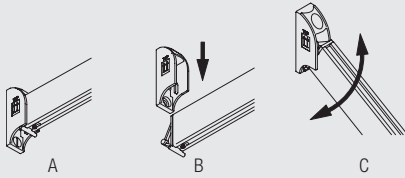

**Wall support 6655 (for right angled fixing of the profile to the wall)**  
 Safety wall support 6655 is uniquely designed to ensure that the track will separate with a direct downward pressure or will tilt to minimise damage.

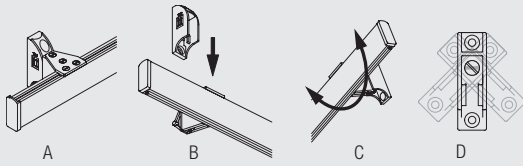

**Wall bracket 6668 (for parallel fixing of the profile to the wall)**  
 Profile separates from wall support at given weight (A,B). The profile will pivot in the bracket (C,D).

Separation loads: The Silent Gliss Safety Device has been designed to separate when a maximum load of 40kg is applied at any point of the cubicle track.

## System Layout Overview

### Layout guide for 6650 safety device system

Typical Track Layout

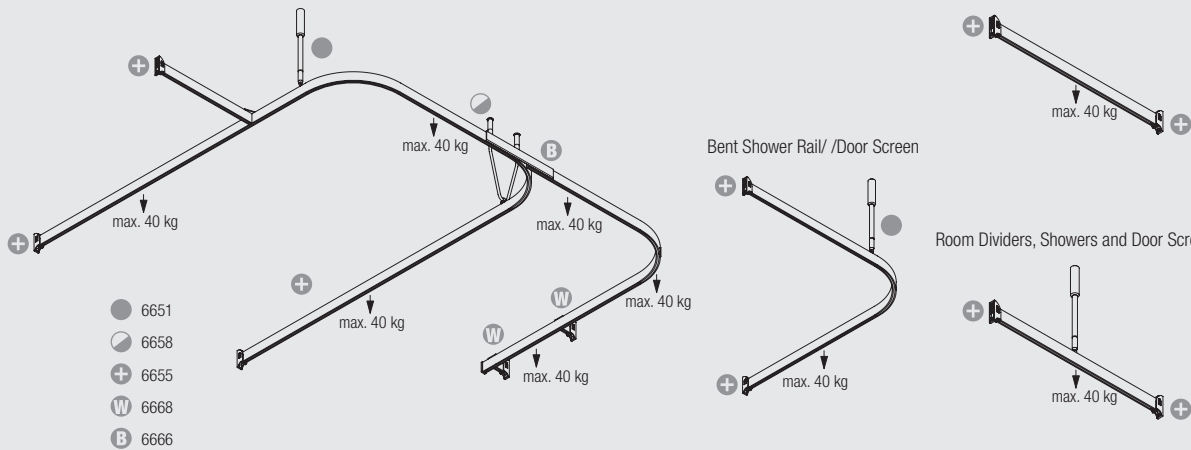

As universal room divider system with various accessories, there are almost no limits to size and layouts. The recommended height from finished floor level to the underside of track is 2100mm

Typical method of obtaining stability is by attaching the system to the corridor wall or window.

## System Layout Options

### Shower application corner and wall

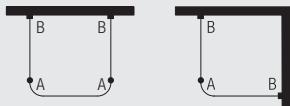

A: hanger rod 6651  
 B: wall support 6655

### Multiple bend application

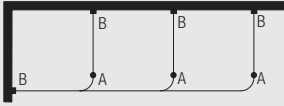

A: hanger rod 6651  
B: wall support 6655

### Multiple straight application

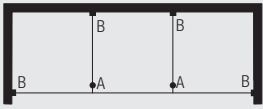

A: hanger rod 6651  
B: wall support 6655

### Typical layout for hospital (without V-hangers)

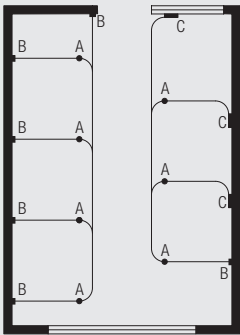

A: hanger rod 6651  
B: wall support 6655  
C: wall support 6668

### Typical layout for hospital (with V-hangers)



6650

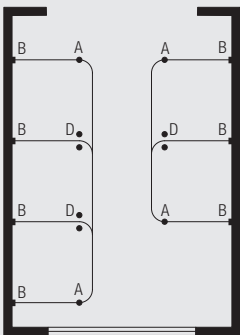

A: hanger rod 6651  
B: wall support 6655  
D: V-hanger 6658

## Fitting Information

The Silent Gliss 6650 system is intended to reduce the risk of self-harm in cubicle situations. In order to work correctly it must be fitted in accordance with the specific 6650 fitting instructions. Failure to do so will reduce its effectiveness. Any queries or anomalies should be reported to Silent Gliss. If you require any information on quality management procedures please contact Silent Gliss.

Fixings should support ends of profile plus changes in direction. Maximum span between supports is 2.5m. The position of supports can affect the performance of the system. Please consult one of the Silent Gliss network of Specialist Distributors.

### Site preparation for suspended ceiling applications

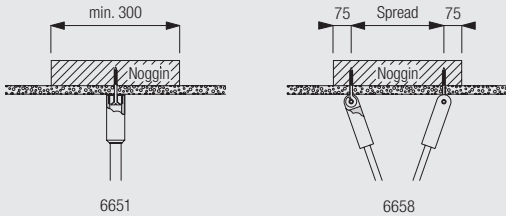

Fixings should support the ends of the profile and any changes in direction. Maximum span between fixings is 300mm.

When fitting to suspended ceilings site preparation is critical. At each hanger position a noggin in approved material is required above the suspended ceiling; underside to rest on top of ceiling (but independently supported) with a minimum length of 300mm at right angles to the track in which the hanger occurs to give fixing tolerance. Ideally the hangers should be on the return track, if on the front track then adequate support should be provided. A detailed information sheet is available on request.

### Dust Cover Strip

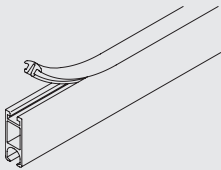

Dust cover strip 6110, reduces the risk of cross infection, (an application for a special patented dustcover - 0715 - reducing the risk of self harm for patients has been applied for).

## Fitting Options

### Ceiling fitting with hanger 6651

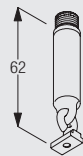
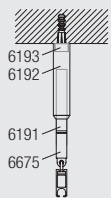

6675  
Safety device for  
vertical hanger

### Ceiling fitting with V-hanger 6658

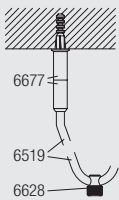

6677  
Safety device for  
V-hanger



6650

Wall fitting with support 6655 (for fixing of profile at right angles to wall)

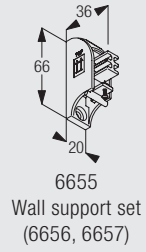
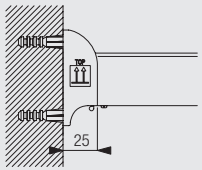

Wall fitting with support 6668 (for parallel fixing of profile to the wall)

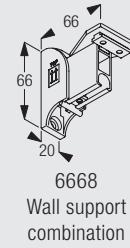
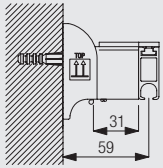

Profile connecting bridge 6666

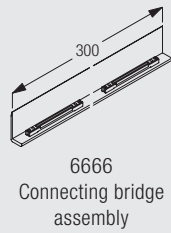
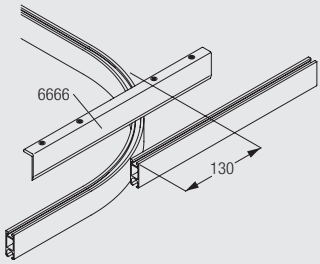





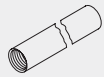

Standard Accessories

0785	Acrylic disk		6101	Profile	
6110	Dust cover		6147	Glider 6144 with hook 6146 in strip form	
6611	Endcover		6655	Wall support set (6656, 6657)	
6663	Wall bracket combination		6666	Connecting bridge assembly	
6668	Wall support combination		6671	Washer insert for countersunk screw	
6672	Screw cover for 6671		6675	Safety device for vertical hanger	

6677	Safety device for V-hanger		
------	----------------------------	---	--

### Sets

6651	Hanger 6651 with safety device 6675	6191	Hanger rod	1	
		6192	Sleeve	1	
		6193	Ceiling stud	1	
		6675	Safety device for vertical hanger	1	
6658	V-hanger with safety device 6677	6519	Hanger rod	1	
		6628	V-hanger track insert	1	
		6677	Safety device for V-hanger	2	

### Useful Information

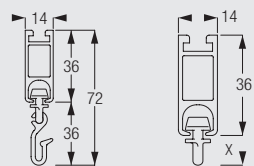

The left hand diagram illustrates the standard measurements for 6101 cubicle/shower system with combined 6147 glider/hook. For non-medical application refer to the right hand illustration and the figures below for the roller/glider dimensions.

- 6083 = 7mm
- 6094 = 31mm
- 6098 = 26mm
- 6283 = 7mm
- 6144 = 9mm

[www.bradingfabrication.com](http://www.bradingfabrication.com)

Brading Fabrication Limited  
3204 Yonge Street  
Toronto, ON, Canada  
M4N 2L2

Tel: 416-488-6600  
Fax: 416-488-9821  
[info@bradingfabrication.com](mailto:info@bradingfabrication.com)