

# Hand Operated Drapery Track Systems

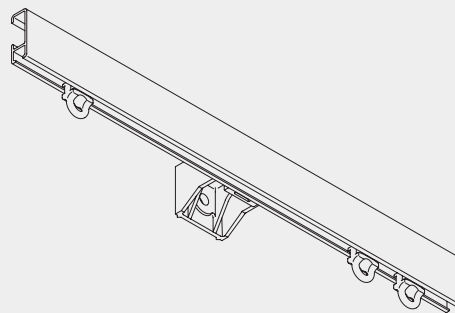

## Hand Operated Drapery Track System

# Silent Gliss® 1080



### Product Information

- Versatile, sturdy hand operated drapery track for residential and contract applications.
- For light to medium weight draperies.
- Very elegant and bendable profile with hidden mounting channel. Particularly suited for deep curtain headings.
- Easy ceiling or wall mounting.
- Wide variety of accessories.
- Standard colors: anodized aluminum or white powder coat.
- Standard length of the profiles are 20'. Systems can be planned to unlimited lengths due to a special connecting bridge.



1080

## Profile and Bending Information

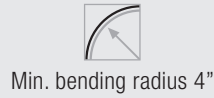
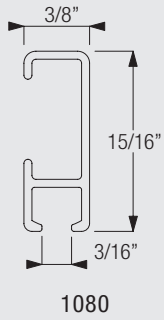

## Mounting Information

### Bracket Positioning and Mounting with universal brackets 3603, 3630, 3655, 3660



The effective measures are defined by the actual height and width of the curtain, its structure and make-up type.



Installation: Roll track onto bracket in direction indicated  
Removal: 1. Press to release 2. Rotate forward for removal

## Mounting Options



### Ceiling mounting with bracket 3603

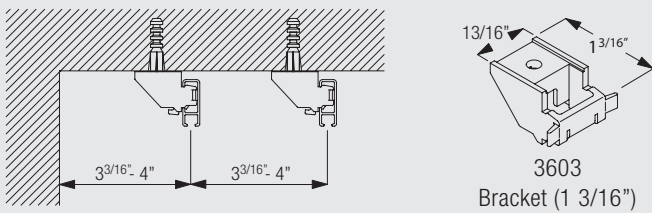

3603  
Bracket (1 3/16")

### Wall mounting with universal brackets 3630/3655/3660

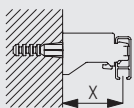

	X (in)
3630	1 7/16
3655	2
3660	2 9/16

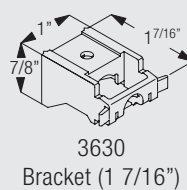

3630  
Bracket (1 7/16")

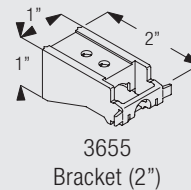

3655  
Bracket (2")

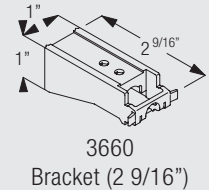

3660  
Bracket (2 9/16")

Wall mounting with adjustable brackets 0829, 0831 with slider 0828 and clamp 3603

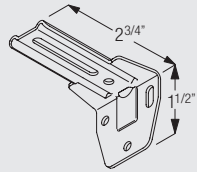
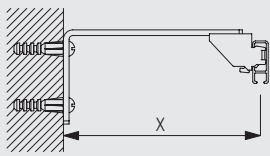

0829  
Wall Bracket (2 3/4")

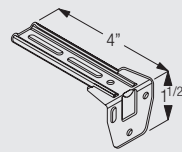

0831  
Wall Bracket (4")

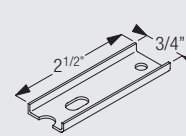

0828  
Slider

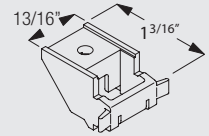

3603  
Bracket (1 3/16")

Standard Accessories

1080	Profile		3070	Eye endstop	
3533	Glider		3603	Bracket (1 3/16")	
3605	End cover				

Optional Accessories

0829	Wall Bracket (2 3/4")		0831	Wall Bracket (4")	
3045	Overlap arm		3606	Snap fastener	
3620	Connecting bridge		3630	Bracket (1 7/16")	
3655	Bracket (2")		3660	Bracket (2 9/16")	



Sewing Accessories

3020	Hook		3511	Glider	
3571	Hook		3582	Hook	
3599	Hook		6146	Hook	

## Useful Measures

3605 End cover

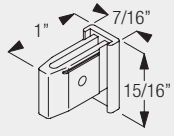

3620 Connecting bridge

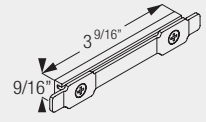

1080

[www.silentgliss-usa.com](http://www.silentgliss-usa.com)

Silent Gliss USA Inc.  
1850 Beaver Ridge Circle, Suite A  
Norcross GA 30071

Phone: 770-466-4811  
Toll Free: 1-800-938-7225  
Fax: 770-466-4814  
[info@silentgliss-usa.com](mailto:info@silentgliss-usa.com)

[www.brading.com](http://www.brading.com)

Brading Specialty Shades  
3204 Yonge Street  
Toronto, ON M4N 2L2

Phone: 416-488-6600  
Toll Free: 1-866-BRADING  
Fax: 416-488-9821  
[info@brading.com](mailto:info@brading.com)