

Hand Operated Drapery Track Systems

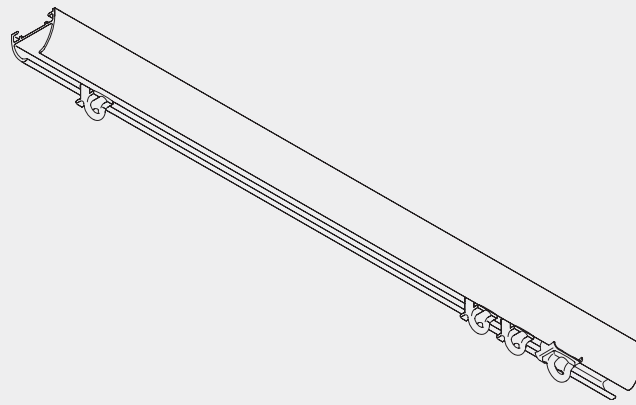

Hand Operated Drapery Track System

Silent Gliss® 6010



Product Information

- Hand operated drapery track for light and medium weight draperies for residential and contract applications.
- Very elegant, bendable profile (Min. radius 12") with hidden mounting channel.
- Unique ceiling mounting technology with hidden, invisible swing clamps.
- Standard colors: anodized aluminum or white powder coated.
- Standard length of the profiles are 20'. Systems can be planned to unlimited lengths due to a special connecting bridge.



6010

Profile and Bending Information

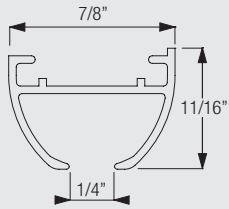

6010



Min. bending radius 12"

System Options

S-Fold / Z-Fold Application



6331



6339



5202



6338



6342



6347



6333

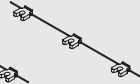

6334

6331 Snap Glider
 6339 Base
 5202 Roller
 6338 Butt Master Center Draw
 6342 Overlap Master
 6347 Butt Master One Way Draw
 6333 100% Spacer Cord
 6334 120% Spacer Cord
 6325/6324 Shoe

Mounting Information

Ceiling mounting with clamp 3825



6010

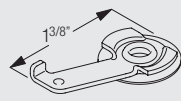
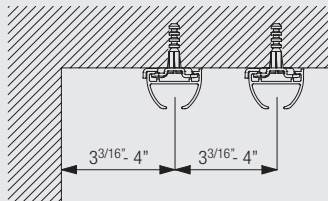

3825
Clamp

Mount track with at least one clamp 3825 every 18" with higher edge of profile to room side. The final distances depend on system height, width and configuration.

Ceiling mounting with bracket 3832

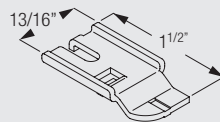
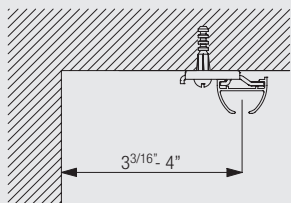

3832
Bracket

Mount track with at least one bracket 3832 every 18" with higher edge of profile to room side. The final distances depend on system height, width and configuration.

Standard Accessories

3825 Swing clamp



6010 Profile



6053 Spring stop



6065 Eye endstop



6283 Roller



Optional Accessories

3802 Connecting bridge

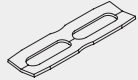

3832 Installation bracket for curved tracks

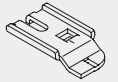

6083 Glider



6094 Roller w/ hook



6146 Hook



Sewing Accessories

3582 Hook



3599 Hook



6349 Curtain tape



6363 Iron tape



6010

Useful Measures

3802 Connecting bridge

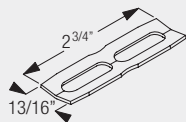

www.silentgliss-usa.com

Silent Gliss USA Inc.
1850 Beaver Ridge Circle, Suite A
Norcross GA 30071

Phone: 770-466-4811
Toll Free: 1-800-938-7225
Fax: 770-466-4814
info@silentgliss-usa.com

www.brading.com

Brading Specialty Shades
3204 Yonge Street
Toronto, ON M4N 2L2

Phone: 416-488-6600
Toll Free: 1-866-BRADING
Fax: 416-488-9821
info@brading.com