

Roller Blind Systems

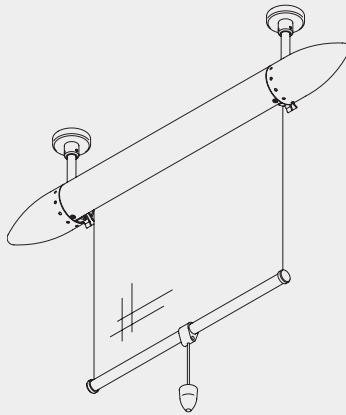

Design Case System

Silent Gliss® 4140 Corazza



Product Information

- Corazza - a unique approach to design, a very special roller blind.
- Suitable for use with 4800 decelerator system or can also be motorised.
- Aluminium case and end covers available in anodised silver or black with matching bottom bar.
- Easy mounting to ceiling, wall or in recess thanks to a simple adjustable bracket system.
- Suitable for fixing two or more roller blinds together with an intermediate bracket.
- Especially attractive when combined with Colorama or screen fabrics.
- Choose from our wide Silent Gliss fabric range (thin fabrics are more suitable since the fabric has to roll up into the cassette). Ask for our fabric collection or visit our showroom.
- Ready assembled, made to measure.
- Choice of design pulls.
- Fixing brackets and pulls come in either matching or coordinating colours.



4140

Profile and Specification Information

Profile

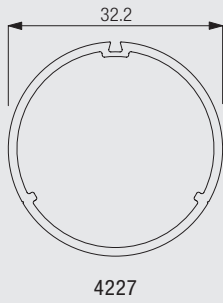

Design Case Corazza

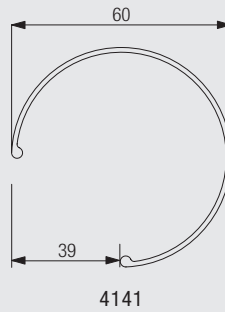

Specification Guide - download from www.silentgliss.co.uk (password required).

Silent Gliss 4140 Corazza, a unique aluminium cased roller blind with customised design elements and 4800 decelerator system with 4228 speed controller and spring clutch or can also be motorised using System 4250. Inside/outside recess fitting with adjustable bracket system 4104.

How to Measure

System measurements by design end cover

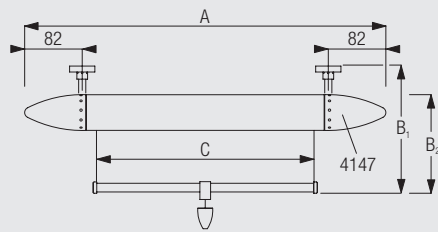

- A: system width
- B1: system drop - top fix
- B2: system drop - face fix
- C: fabric width

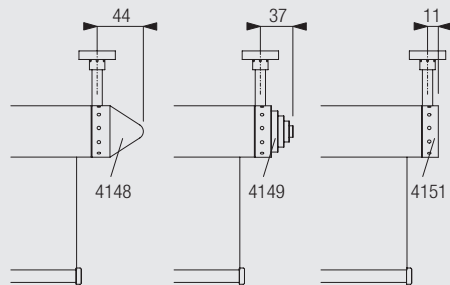

- 4147: End cover 'Bolide' (82mm x 2)
- 4148: End Cover 'Circus' (44mm x 2)
- 4149: End Cover 'Icicle' (37mm x 2)
- 4151: End Cover 'Puck' (11mm x 2)

Attention: the total width of the system includes the width of the design endcaps.

Please use a Silent Gliss measure sheet when measuring for your blinds. These can be obtained from Head Office or found on the Silent Gliss website (password required) www.silentgliss.co.uk.

Side-by-side fitting of various systems

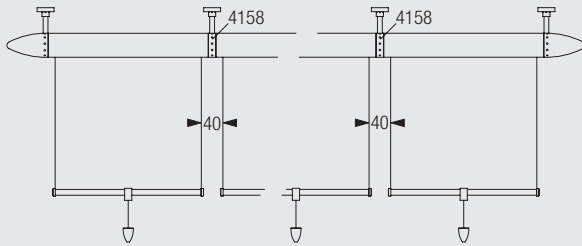

4158: Intermediate design bracket (width 16mm)

Multiple systems can be fitted side-by-side.

System Dimensions



2m plus
endcovers



46cm plus
endcovers



3m



6



1.6

Maximum drop of 4140 Corazza according to fabric

Fabric	Max. drop
Colorama 1	2.8 m
Colorama 2	2.3 m
Triscreen	2 m
Puma 2000	2.5 m
Natté 3500	2.6 m
Thermoscreen	1.9 m
Sunscreen 550	1.2 m
Vision	3 m
Euroshade 2	3 m



Fabric width according to end covers

Endcover	Fabric width =
Bolide	System width - 22.5 cm
Circus	System width - 14.5 cm
Icicle	System width - 13.5 cm
Puck	System width - 7.5 cm

Design Elements

Endcovers

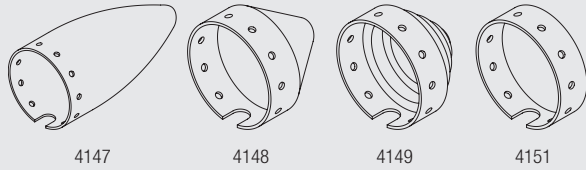

4147: 'Bolide'
 4148: 'Circus'
 4149: 'Icicle'
 4151: 'Puck'

Available in black or silver to match the design case.

Pulls



4152: 'Pull'
 4153: 'Anchor'
 4154: 'Bullet'

Please note 4154 bottom bar connector is colour matched, but bullet is black.

Fitting Information

Bracket positioning for ceiling / wall fixing

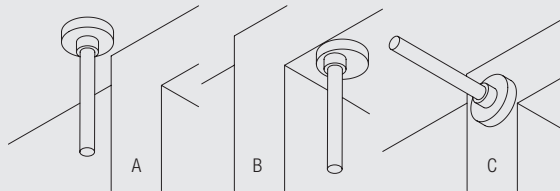

Attention: Please note that if fitted inside a window recess (B), all endcovers including Puck will leave a light gap.



4140

Fitting Options

Ceiling fix - outside of window recess

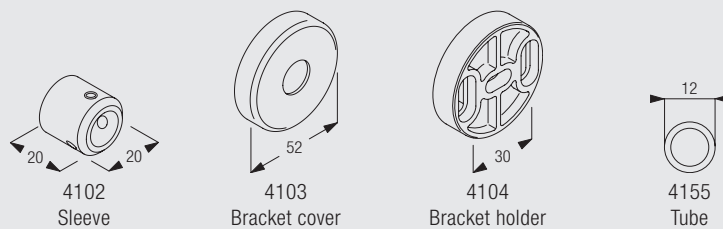
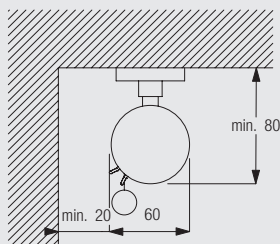

Ceiling fix - inside of window recess

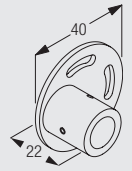
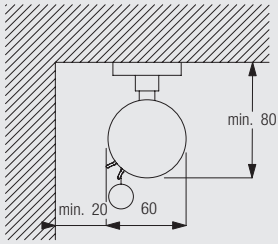

4143
Recess bracket
holder

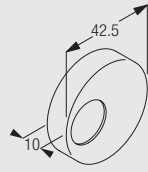

4144
Recess bracket cover

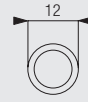

4155
Tube

Wall Fix

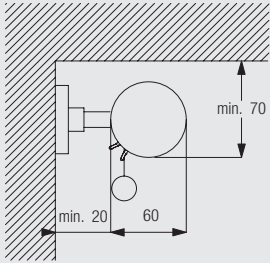

4102
Sleeve



4103
Bracket cover



4104
Bracket holder



4155
Tube

Standard Accessories

4102	Sleeve		4103	Bracket cover	
4104	Bracket holder		4139	Bottom bar endcover (ø 19mm)	
4141	Profile		4147	Endcover (Bolide)	
4148	Endcover (Circus)		4149	Endcover (Icicle)	
4151	Endcover (Puck)		4152	Pull grip	
4153	Anchor grip		4154	Bullet grip	
4155	Tube		4165	Bottom bar	
4187	Strip		4227	Profile	
6178	Special hexagonal head screw				



Optional Accessories

4143 Recess bracket holder



4144 Recess bracket cover



4158 Connector



Electric Operation Option

System 4140 can be motorised - system 4850 - and can be operated by fixed switch or radio control. Please contact Silent Gliss for more information.



4140

www.bradingfabrication.com

Brading Fabrication Limited
3204 Yonge Street
Toronto, ON, Canada
M4N 2L2

Tel: 416-488-6600
Fax: 416-488-9821
info@bradingfabrication.com